

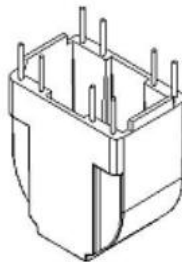

P/N: 02.13.01140

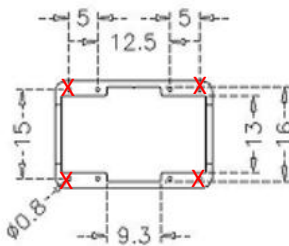
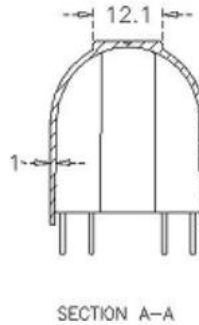
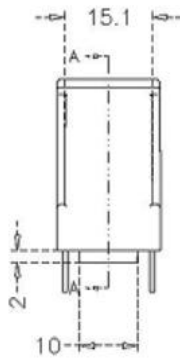
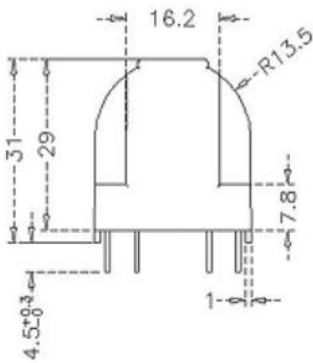
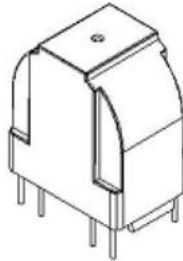
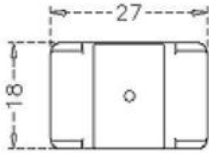

2024.06.2

张麟<sup>8</sup>

10:31:05

+08'00'

序号	料号	去除脚位	PIN长	序号	料号	去除脚位	PIN长
1	02.13.01140	PIN1,4,5,8	4.0±0.2	4			
2				5			
3				6			



Anhui Shirui Electronic Technology Co.,Ltd

www.shiruitech.com TEL:(0086)55165232650 sales@shiruitech.com

SR NO: SR-CASE028	MATERIAL: A3X2G5	UNIT:mm TOLERANCE 0<X<4 ±0.1 4<X<16 ±0.2 16<X<63 ±0.3 PIN PITCH ±0.2	DRN:	Rick
	ULREC: UL94V-0		CHD:	Leo
MODEL NAME: CASE028 (4+4)P	ANGLE:±° SCALE 1:1		ISSD:	Jike