

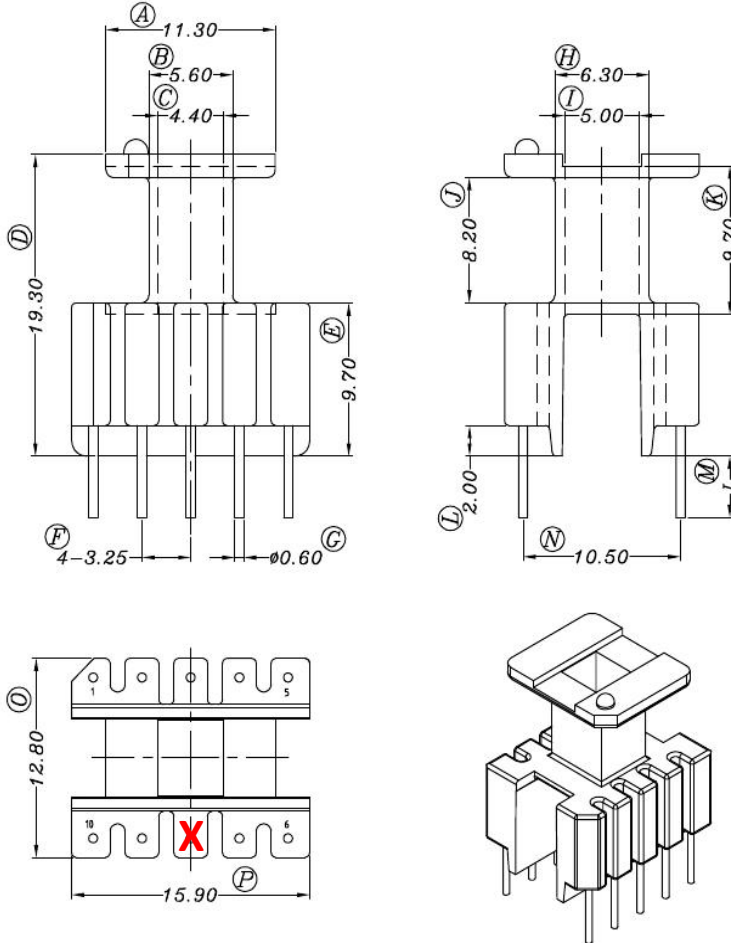

P/N: 02.03.00859



数字签名
者: 张杨
日期: 2024.04.22
14:36:21
+08'00'

张杨

序号	料号	去除脚位	PIN长	序号	料号	预留脚位	PIN长
1	02.03.00859	PIN8	3.5±0.3	4			
2				5			
3				6			



Anhui Shirui Electronic Technology Co.,Ltd

www.shiruitech.com TEL:(0086)55165232650 sales@shiruitech.com

SR NO: SR-EE1652	MATERIAL: Phenolic	UNIT:mm TOLERANCE 0<X<4 ±0.1 4<X<16 ±0.2 16<X<63 ±0.3 PIN PITCH ±0.2	DRN:	Rick
	ULREC: UL94V-0		CHD:	Leo
MODEL NAME: EE16 (5+5)P-1S V	ANGLE:±° SCALE1:1		ISSD:	Jike