

P/N:

01.05.00528

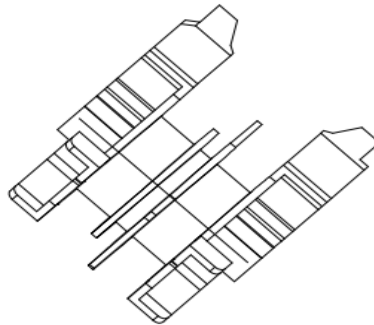
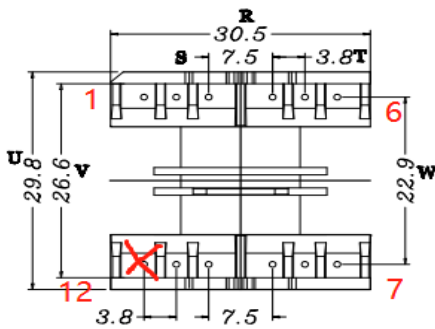
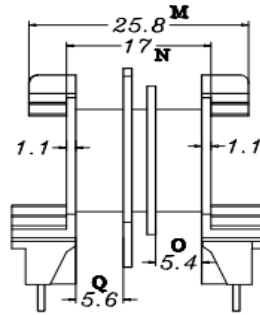
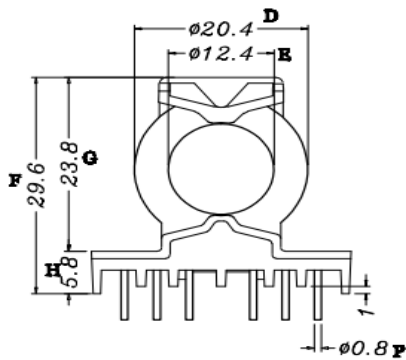
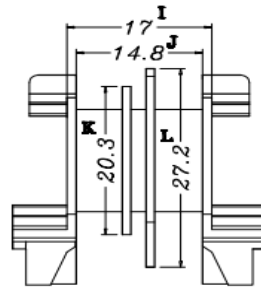
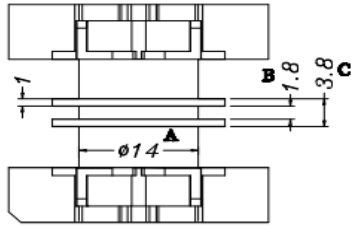

李黎

2023.7.31 09:01:53  
+08'00'





标“△”为重点尺寸

序号	料号	去除脚位	PIN长	序号	料号	预留脚位	PIN长
1		PIN12	4.5±0.5mm	4			



Anhui Shirui Electronic Technology Co.,Ltd

www.shiruitech.com TEL:(0086)55165232650 sales@shiruitech.com

SR NO: SR-PQ2701	MATERIAL: PHONELIC	UNIT:mm TOLERANCE 0<X<4 ±0.1 4<X<16 ±0.2 16<X<63 ±0.3 PIN PITCH ±0.2	DRN:	Rick
	ULREC: 94V-0		CHD:	Leo
MODEL NAME: PQ2701 (6+6)P-3S H	ANGLE:±°   SCALE1:1		ISSD:	Jike