

P/N: 02.03.00612

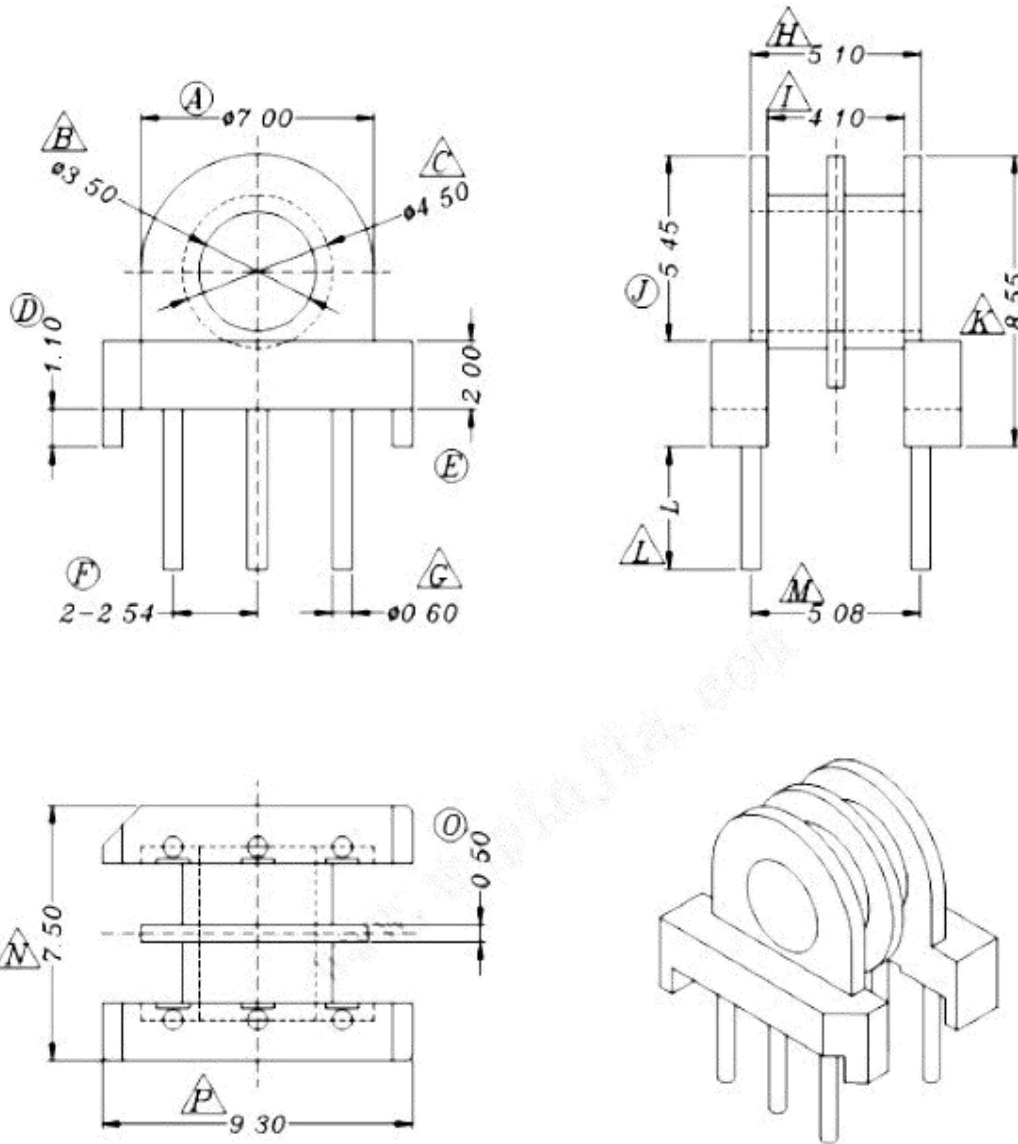

序号	料号	去除脚位	PIN长	序号	料号	预留脚位	PIN长
1	02.03.00612	无	3.25±0.2mm	4			
2				5			
3				6			



Anhui Shirui Electronic Technology Co.,Ltd

www.shiruitech.com TEL:(0086)55165232650 sales@shiruitech.com

SR NO: SR-EP0705	MATERIAL: PHENOLIC	UNIT:mm TOLERANCE 0<X<4 ±0.1 4<X<16 ±0.2 16<X<63 ±0.3 PIN PITCH ±0.2	DRN:	Rick
	ULREC: UL94V-0		CHD:	Leo
MODEL NAME: EP07 (3+3)P-2S H	ANGLE:±°  SCALE 1:1		ISSD:	Jike