

P/N:

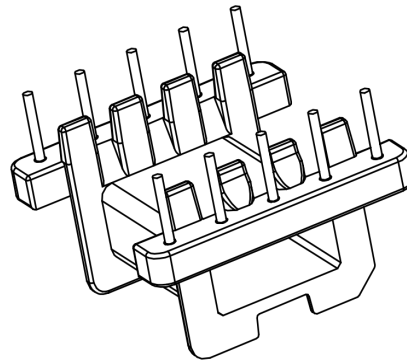

序号	料号	去除脚位	PIN长	序号	料号	预留脚位	PIN长
1				4			
2				5			
3				6			

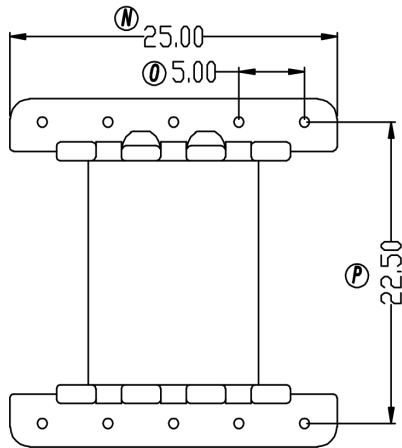
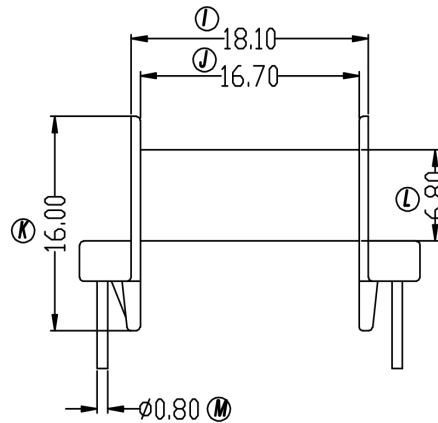
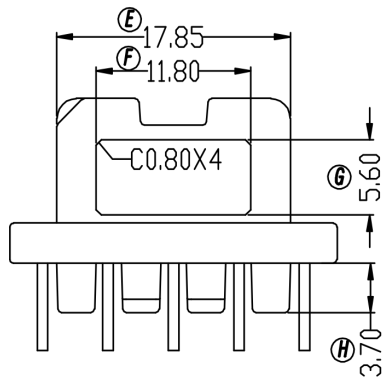
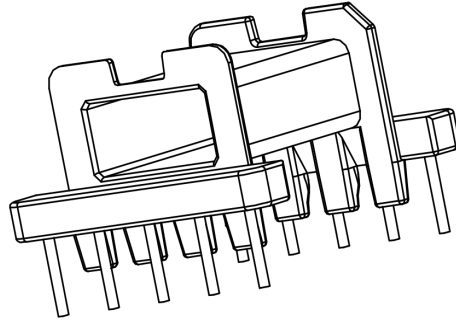
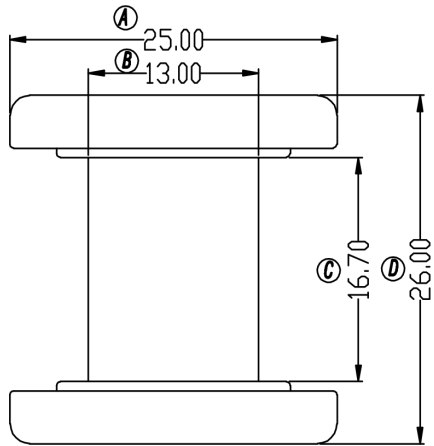

**Anhui Shirui Electronic Technology Co.,Ltd**

www.shiruitech.com TEL:(0086)55165232650 sales@shiruitech.com

SR NO: SR-EFD2509	MATERIAL: PHENOLIC	UNIT:mm TOLERANCE 0<X<4 ±0.1 4<X<16 ±0.2 16<X<63 ±0.3 PIN PITCH ±0.2	DRN:	Rick
	ULREC: UL94V-0		CHD:	Leo
MODEL NAME: EFD25 (5+5)P-1S H	ANGLE:±°  SCALE1:1		ISSD:	Jike